

SPessori / THICKNESSES

- Standard 70-100
Standard 70-100
- Su misura 70-100-130-a richiesta
Custom 70-100-130-on demand

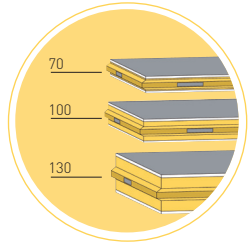

DIVISORIO AGGANCIATO / CAM LOCKS DIVIDING COLLECTION

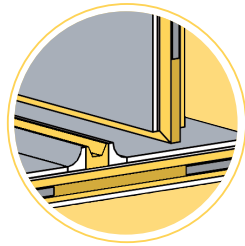

DIVISORIO MOBILE / MODULAR DIVIDING

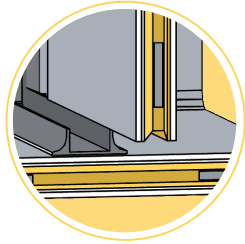

ALTEZZE / HEIGHTS

Esterna = interna + 2S

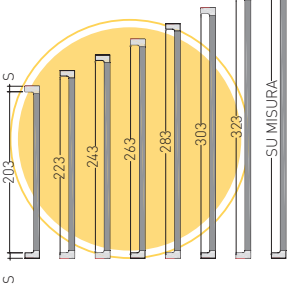

SOFFITTO / ROOF

Soffitto con travatura esterna di sostegno per luci oltre i 3,2 mt
Beams support for roof length greater than 3,2 mt

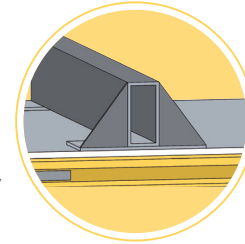

LARGHEZZA PROFONDITÀ / LENGTH WIDTH

Esterna = interna + 2S

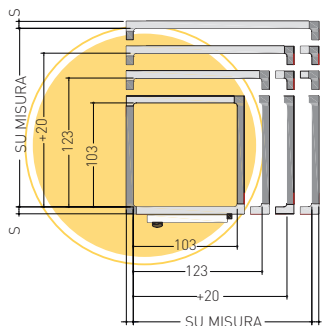

ACCESSORI / OPTIONAL



ANGOLI ARROTONDATI INTERNI / INSIDE ROUNDED CORNERS

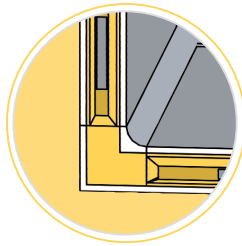

INCASTRO MASCHIO-FEMMINA / MALE-FEMALE NESTING

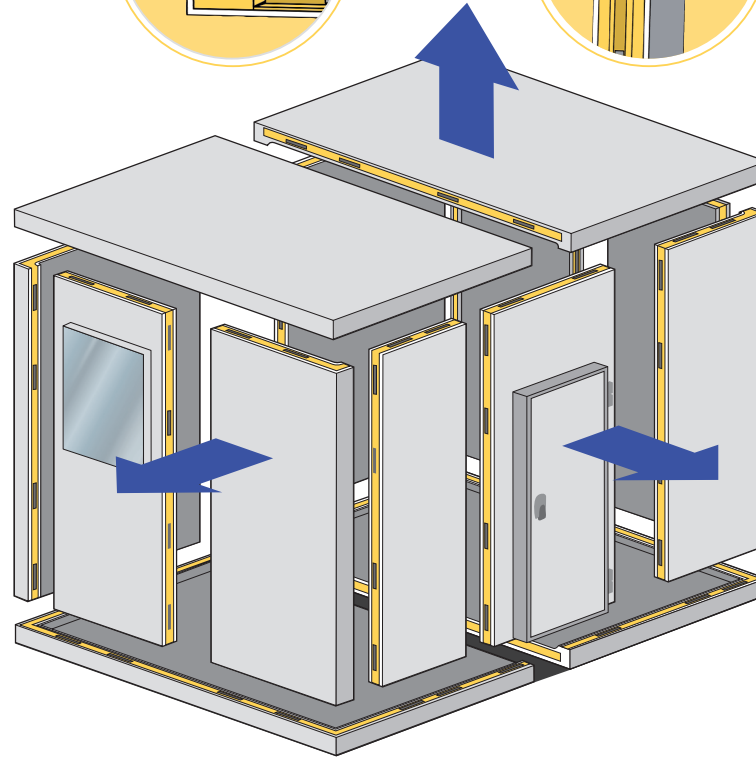
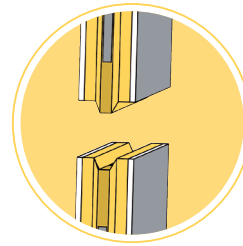

RIVESTIMENTO PANNELLI / PANELS FINISHING

- Lamiera zincoplasticata spessore 6/10 mm + PVC bianco atossico spessore 120 micron, certificata per uso alimentare.
Galvanized sheet steel with plastic coating in rigid white PVC 120 micron thick non toxic.
- Acciaio inox 18/10 AISI304 satinato opaco.
AISI304 18/10 stainless steel scotch bright / dull.
- Lamiera zincoplasticata, colore a richiesta.
Galvanized sheet steel with plastic coating in different colours.



UNIONE CON GANCI ECCENTRICI A DOPPIO EFFETTO / CONNECTION WITH DUAL EFFECT CAM LOCKS

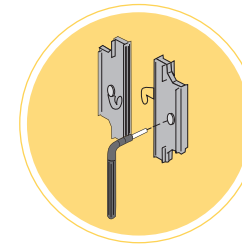

ISOLAMENTO / INSULATION

- Poliuretano espanso ad alta densità 40-42 kg/m³, auto-estinguente secondo la norma ISO 3582, privo di CFC.
High density polyurethane foam 40-42 kg/m³, fire retarding according ISO 3582, CFC free.
- Coefficiente di conducibilità termica 0,021 W/m² °K.
Thermal conductivity coefficient Lambda 0,021w/m² °k.
- Coefficiente di trasmissione K per spessore 70 mm 0,30 W/m² °K, per spessore 100 mm 0,21 W/m² °K.
Transfer coefficient k thicknesses 70 mm 0,30 w/m² °k thicknesses 100 mm 0,21 w/m² °k.
- Resistenza alla compressione 1,5-2 Kg/cm².
Compression resistance 1,5 - 2 kg/cm².

PAVIMENTO / FLOOR

- Senza pavimento con fornitura di profilo sanitario "U" in PVC tondo per il fissaggio delle pareti cella al pavimento di appoggio.
Without floor is supplied with rounded PVC.
- Lamiera zincoplasticata grigia antiscivolo spessore 7/10 mm.
Galvanized steel 7/10 mm thick with non-slip grey plastic coating walk-in static load 2000 kg/m².
- Acciaio inox 18/10 AISI304 bugnato antiscivolo spessore 6/10 mm, pedonabile, portata statica 2000 kg/m².
AISI304 18/10 stainless steel no-slip punch thick 6/10 mm walk-in static load 2000 kg/m².
- Carrellabile 250 kg con rinforzo in multistrato fenolico spessore 10 mm.
Suitable for trolley 250 kg reinforced with 10 mm phenolic multistratified wood.
- Carrellabile 1000 kg con rinforzo in multistrato fenolico spessore 12 mm e travetti di ripartizione carico, copertura in alluminio mandorlato spessore 3 mm.
Suitable for trolley 1000 kg reinforced with 12 mm phenolic multistratified wood, wood beams support 3 mm aluminium sheet cover.

